



Users' manual

Electronic Theodolite
FET 420K / FET 405K



CONTENTS

1)	Important	3
2)	Usage	3
3)	Features (1)	4
4)	Features (2)	4
5)	Display indication	5
6)	Operating panel	5
7)	Preparation for measurement	6
8)	Power on	7
9)	Battery indication	8
10)	Battery replacement	8
11)	Angle measurement	9
12)	Horizontal angle OSet	9
13)	Measuring horizontal and vertical angle (HR, V or HL, V)	10
14)	Mode conversion of horizontal rightward (HR) and leftward (HL) turning increment	10
15)	Horizontal angle locked - unlocked	11
16)	Measurement of zenith distance, vertical angle and height angle	12
17)	Angular repeated measurement	13
18)	Function setting	14
19)	Setting methods	14
20)	Factory settings	15
21)	Error display	15
22)	Mount and dismount of the base plate	16
23)	Check and adjusting	16
24)	Technical specification	22
25)	Care and cleaning	22
26)	Intended use of instrument	22
27)	Safety instructions	23
28)	Specific reasons for erroneous measuring results	23
29)	Electromagnetic acceptability (EMC)	23
30)	CE-conformity	23
31)	Guarantee	24
32)	Exceptions from responsibility	24

1 IMPORTANT! READ THIS BEFORE USING YOUR INSTRUMENT

- Make a full check for the instrument before using it. Be sure that the instrument's functions, power, original settings and revised parameters meet your requirements before you operate it.
- To avoid direct sunlight to the instrument's lens, never leave the instrument exposed to extreme heat longer than necessary, or it could affect the instrument's accuracy.
- When mounting or dismounting the instrument to or from the tripod, hold the instrument by one hand, turn the central screw on the tripod by the other hand to prevent the instrument from falling. If the instrument must be carried on the tripod, hold the instrument as vertically as possible. Never carry the instrument horizontally over your shoulder. Any long distance transport should be done with the instrument in the carrying case.
- Put the instrument in the carrying case to avoid extrusion, crash and shock during the transportation. Shockproof cushion should be necessarily put inside the carrying case during the long distance transportation.
- Clean the dirt on the surface of the organic glass and plastic by floss or brush after using the instrument. Dry the instrument in time after use in the rain.
- Do not use harsh chemicals to clean the surface of the organic glass and plastic components. A water dampened rag is all that is necessary.
- Use absorbent cotton or lenses tissue to clean the exposed optical parts. Handkerchief, clothes or other things like that are forbidden for cleaning.
- The instrument should be stored in an area of low humidity and good ventilation, where the temperature will not exceed 110° F(45°C). It should be necessary to replace the desiccant regularly in the carrying case.
- Always remove the batteries before storing the instrument.
- Please contact our company if the instrument's functions appear abnormal. Non-professional repairers are forbidden to disassemble the instrument.

2 USAGE

Electronic Digital Theodolite FET 420/405K series has adopted increment-mode digits system for angle measurement.

The resolving power of horizontal and vertical angles can reach 10".

The precision of angle measurement can reach 20".

Electronic Digital Theodolite FET 420/405K can be widely used in 3-4 class national triangle control measurement, precise lead measurement, engineering measurement for mine, railway water conservancy and so on, landform measurement, and also could be used in the assembly of the large machinery facilities.

The displays are illuminated so as to make it convenient to operate in the darker environment.

3 FEATURES (1)

- 1) Optical sight
- 2) Objective lens
- 3) Horizontal clamp knob
- 4) Horizontal tangent screw
- 5) Display
- 6) Operating keys
- 7) Tripod base plate
- 8) Carrying handle
- 9) Handle screw
- 10) Instrument center mark
- 11) Plate vial
- 12) Circular vial

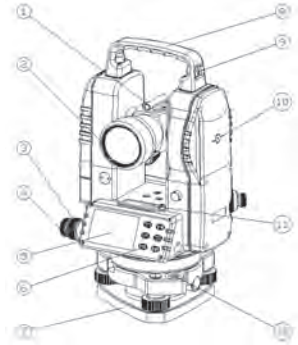

4 FEATURES (2)

- 1) Focusing knob
- 2) Optical plummet
- 3) Communication plug
- 4) Footscrew
- 5) Battery compartment
- 6) Telescope eyepiece
- 7) Vertical clamp knob
- 8) Vertical tangent screw
- 9) Clamp of tribrach

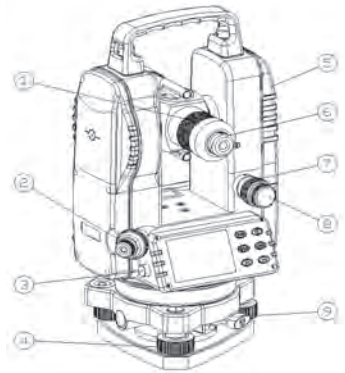

5 DISPLAY INDICATION

- 1) Ht General value of repeated measurements
- 2) V Vertical angle
- 3) Number of repeated measurements
- 4) AVG Average of repeated measurements
- 5) Hr Right horizontal angle
- 6) HL Left horizontal angle
- 7) TILT Incline compensator function
- 8) F Optional function keys
- 9) G Angle unit GON
- 10) % Vertical slope %
- 11) REP State of repeated measurement
- 12) BAT Battery state indication

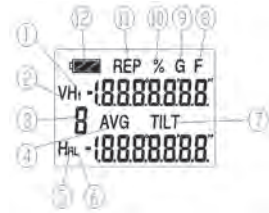

If display shows “b” after activating incline compensation function, which means exceeded compensation range, the instrument should be levelled.

6 OPERATING PANEL

Button	Function
FUNC	Optional function keys
	Lighting switch for display window
REP	Repeated angle measurement
HOLD	Hold horizontal angle
V/%	Vertical angle display Vertical angle/percent display
R/L	Option of left/right horizontal angle
OSET	OSET for horizontal angle
	Power switch
	Move cursor leftward
	Move cursor rightward
	Alter the number cursor indicated

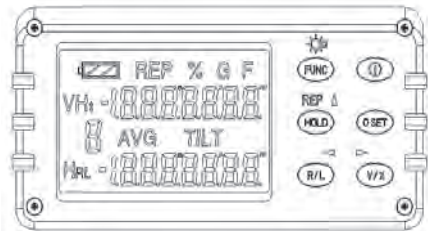

7 PREPARATION FOR MEASUREMENT

Level and center the instrument precisely to ensure its best performance.

- a Mount the tripod
Firstly place the tripod legs to a suitable position and tighten the locking device.
- b Mount the instrument
Attach the instrument to the tripod carefully, and then move the instrument by loosening center screw. Lock slightly the center screw on the tripod when the plummet is centered above the mark.
- c Roughly level the instrument with the circular vial
 - 1 Use footscrew 1, 2 to move the air bubble in the circular vial so it is centered left to right.
 - 2 Use footscrew 3 to move the air bubble to the center of the vial.

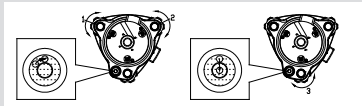

- d Fine tune level the instrument with the plate level
 - 1 Loosen horizontal clamp knob. Turn the instrument to place the plate vial parallel with the footscrew 1, 2. Center the bubble using these two footscrews. Attention: Turn the two foot screws reversely when you adjust them.
 - 2 Turn the instrument 90° and center the bubble using level screw 3.
 - 3 Repeat step 1, 2 every time the instrument is turned 90° to center all the bubbles in these positions.

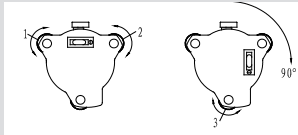

- 4 Return to the original position in step A. Rotate the instrument 180° . The plate vial is mounted correctly and the instrument is leveled nicely if the bubble is centered no matter the instrument is rotated in any direction. At the position of step 1, rotate the collimating section 180° . The plate level is mounted correctly and the instrument is levelled nicely if the bubble is centered no matter what direction the collimating section is rotated.

Please pay attention to the relations between the turning direction of the level screws and the moving direction of the bubble.

Adjust the plate level if the bubble is not centered in step 4

- e Centering the instrument using the optical plummet
Adjust the eyepiece according to the observer's eyesight, then move the instrument by loosening center screw until the image of the sign on the ground centered in the circle of the reticule. Move the instrument carefully in case it appears incline.

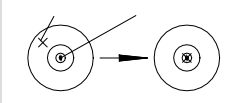

- f Final levelling of the instrument
Level the instrument precisely in the similar way to step 4. Rotate the instrument to see if the bubble in the plate vial is centered, then tighten the center screw.

8 POWER ON

- a When pressing the button  by 1 sec. audio tone sounds and after a test period of about 2 seconds in which all segments are displayed instrument is ready for use.
- b Move telescope to activate vertical angle reading.
- c Push **V%** button to show vertical angle "0" point.

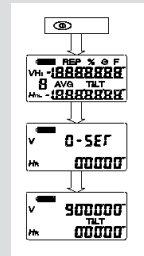

Target "0"

The instrument has been equipped with "0" pointer in the vertical scale panel in order to set the vertical angle "0" point. Rotate the telescope to pass a sensor through the zero pointer and start angle measurement. The "0" point is set near the horizontal place, so it is easy to set the vertical "0" by rotating the telescope.

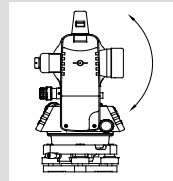

The instrument can measure horizontal angle without **0**set for the specification of the vertical plate.

For the instrument equipped with the automatic compensatory "0"set device, the vertical specification can not be compensated "0"set automatically if the degree out of the vertical exceeds the design range, and the instrument will display symbol "B". The instrument will not be recovered until it is releveled precisely and the symbol "B" disappears.

9 BATTERY INDICATION

The battery symbol on the display shows the current battery state.



Full power

Effective

Effective

Low power but effective, replace the battery.

Instrument will shut off automatically shortly. Replace batteries immediately.

Battery operating time will vary depending on type, brand and quality of the battery. We suggest always to secure for a 2nd standby battery set.

For any questions about replacing batteries, see chapter "battery replacement".

10 BATTERY REPLACEMENT

a Removing the battery

Push down the press button and remove the battery compartment.

b Battery replacement

Push down the hook to pull cover board away from the battery compartment.

Replace the old batteries by new ones. Take care of correct polarity.

Snap the battery cover back into place.

c Mounting battery compartment

Slip the projection on the bottom of the battery compartment into the slot. Push the press button on top of the battery compartment until it clicks into place.

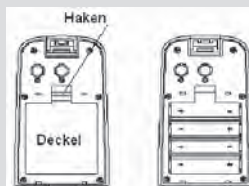

11 ANGLE MEASUREMENT

Vertical plate left/right observation

"Plate left" means the vertical plate is on the left side by the telescope when the observer faces the eyepiece. "Plate right" means the opposite to the "plate left". Taking the average reading of the "plate left" and "plate right" as the observation value can effectively remove the corresponding effect on the observer from the system errors in the instrument. Therefore, turn the telescope 180° for the "plate right" observation after the accomplishment of the "plate left" during the observation of the horizontal and vertical angle.

Target aim

Point the telescope at the brightness and focus the eyepiece until the crosshair can be seen clearly. (Turn the focusing knob in the direction facing the observer, then focus in reverse direction.)

Aim at the target coarsely using the coarse aiming device. The definite space can be kept between the device and the observer when aiming coarsely.

Focus the target by turning the focusing knob on the telescope.

Attention:

The visual errors of the target and reticule crosshair will be created in the horizontal and vertical direction if the telescope or the eyepiece are not focused precisely, which can result in the measuring errors. Focus for the telescope and eyepiece should be necessary to remove the visual errors.

12 HORIZONTAL ANGLE OSET (OSET)

OPERATING PROCESS

Aim at target A using crosshair of the telescope.

Press **OSET** key once to set reading of horizontal angle 0°00' 00":

OSET key is only effective to the horizontal angle.

Horizontal angle can be set **0** at any time except the holding state(**HOLD** key).

DISPLAY



13 MEASURING HORIZONTAL AND VERTICAL ANGLE (HR, V or HL, V)

Horizontal rightward turning increment and vertical angle measurement /HR, V)

OPERATING PROCESS

Aim at target A using crosshair of the telescope.

Press **OSET** key once to set reading of horizontal angle $0^{\circ}00'00''$.

Turn instrument clockwise and aim at the second target B to get its horizontal and vertical angle.

DISPLAY

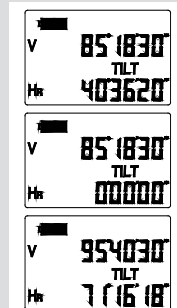

14 MODE CONVERSION OF HORIZONTAL RIGHTWARD (HR) AND LEFTWARD (HL) TURNING INCREMENT

OPERATING PROCESS

Aim at target "A" using crosshair of the telescope.

Press **R/L** key, transform horizontal angle mode HR into the mode HL.

Measuring by mode HL.

R/L key is of no effect to the vertical angle.
Press **R/L** key again, transform mode HL into mode HR.

DISPLAY

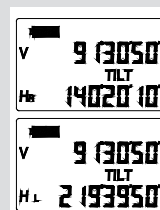

15 HORIZONTAL ANGLE LOCKED - UNLOCKED

During the process of level observation, press **HOLD** key once to keep the measuring angle. After the horizontal angle held, the value of the horizontal angle on the display window blinks. There is no change to the horizontal angle even if the instrument is rotated. When the direction aimed correctly, press **HOLD** key once again to unlock the holding state. The direction of the horizontal angle the instrument currently aimed is just the angle locked before.

OPERATING PROCESS

Turn the tangent knob and place the required horizontal angle.

Press **HOLD** key once, hold and flicker the value of the horizontal angle.

Aim at the target.

Press **HOLD** key, no blink and hold to the value of the horizontal angle.

HOLD key is of no effect to the vertical angle.

DISPLAY

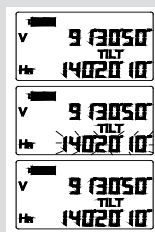

16 MEASUREMENT OF ZENITH DISTANCE, VERTICAL ANGLE AND HEIGHT ANGLE

The vertical angle should be originally set according to the needs before the operation.

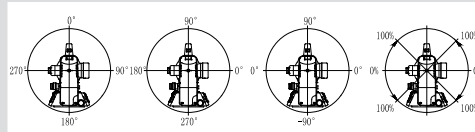

ZENITH DISTANCE

If choose 0° for the vertical angle as the zenith direction, the measured vertical angle V is the zenith angle.

$$\text{ZENITH DISTANCE } V = (L + 360^\circ - R) / 2$$

$$\text{SPECIFICATION ERROR } i = (L + R - 360^\circ) / 2$$

VERTICAL ANGLE

If choose 0° for the vertical angle in left direction, the measured vertical angle V is the vertical angle.

$$\text{VERTICAL ANGLE } V = (L + 180^\circ - R) / 2$$

$$\text{SPECIFICATION ERROR } i = (L + R - 540^\circ) / 2$$

HEIGHT ANGLE

If choose 0° for the vertical angle in both left and right direction, the measured vertical angle V is the height angle.

$$\text{HEIGHT ANGLE } V = (L + R) / 2$$

$$\text{SPECIFICATION ERROR } i = (L - R) / 2$$

ATTENTION: If SPECIFICATION ERROR $|i| \geq 10''$ inspect and adjust according to the instruction manual.

SLOPE PERCENT MODE (slope angle measurement)

Measuring in angle mode, the vertical angle could be transformed into percent of grade.

The percent of grade value = $H/D * 100\%$:

The range of grade percent is from the horizontal direction to $\pm 45^\circ$.

OPERATING PROCESS

Press **V%** key to switch from vertical angular measurement shown in degrees to percent.

Press **V %** key once again back to the angular measurement shown in degrees.

Any angle exceeding 100% the percent of grade will be shown as "-----" on the display.

DISPLAY

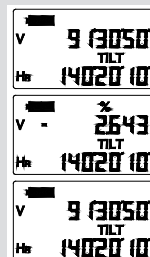

17 ANGULAR REPEATED MEASUREMENT

OPERATION PROCESS

- 1 Press **FUNC** key.
- 2 Press **REP** key to put the instrument in repeated mode.
- 3 Aim at target A and press **OSET** key once to set the first target reading 0°00' 00".
- 4 Turn the horizontal tangent knob to aim at the second target B.
- 5 Press **HOLD** key to hold the horizontal angle and store in the instrument.
- 6 Turn the horizontal tangent knob to aim at the target A again. Press **R/L** key to release the angle and keep the state.
- 7 Turn the horizontal tangent knob to aim at the target B again.
- 8 Press **HOLD** key to hold the horizontal angle and store in the instrument. Double and average angle-value will be shown on the display.
- 9 Repeat steps 7 and 8 according to measuring requires.
- 10 Back to normal angular measurement, press **FUNC** key, then press **HOLD** key.

DISPLAY

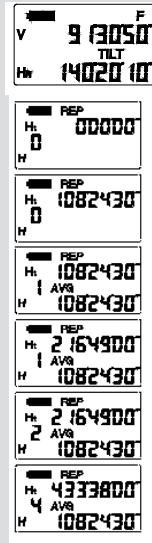

The reading of horizontal angle could reach at least $\pm 2000^{\circ}00' 00''$ when measuring in "Plate left" or "Plate right" mode. The five-seconds reading could reach at least $\pm 1999^{\circ}59' 59''$.

The repeated measurement should be limited within 15 times when the instrument is in the repeated mode, otherwise an error will be shown.

Error E04 will be shown on the display when measured error every time exceeds or equals $\pm 30''$ during the repeated measurement, go back to step 3.

Press **FUNC** key, then press **HOLD** key to back to the original state.



18 FUNCTION SETTING

The instrument supplies multi-functions for your option to meet different requires of measuring configuration.

ITEM	INSTRUCTION	PARAMETER SETTING	
1	Minimum reading	Change between 10" and 20"	Setting 0 10" Setting 1 20"
2	Quadrant signal tone	Confirm every 90° by signal tone	Setting 0 off Setting 1 on
3	Unit of angle measurement	Change between DEG, (degree), GON, MIL	Setting 0/DEG Setting 1/GON Setting 2/MIL Setting 3/DEG
4	Auto shut-off	Set interval for automatic shut-off	Setting 0/Off Setting 1/10 min. Setting 2/20 min. Setting 3/30 min.
5	Measuring mode for vertical angle	Set „0" point of vertical angle	Setting 0 Vertical angle (0 in horizontal) Setting 1 Zenith angle (0 in zenith) Setting 2 Height angle +/- (0 in horizontal)
6	Automatic compensation	Set incline correction function	Setting 0 Off Setting 1 On
7	Data transmission	Set data transmission function	Setting 0 Off Setting 1 On

19 SETTING METHODS

Power on the instrument, press **FUNC** key, then press  key. The instrument enters the state of the original setting mode, display as follows:

To select the required parameter use  and  keys.

To change to correct parameter use  key.

To store the settings press **FUNC** key first and then .

The settings will be stored even if the unit has been shut off.

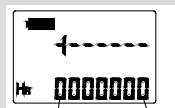

20 FACTORY SETTINGS

Minimum reading	10"
Quadrant signal tone	off
Unit of angle measurement	360°
Automatic shut-off	off
Vertical angle measuring-mode	zenith angle
Automatic compensation	off
Data transmission	off

21 ERROR DISPLAY

DISPLAY ERROR CONTENT AND DISPOSAL

B	Vertical compensator out of compensating range. Level the instrument again.
E00	Collimate rotating too fast. Press OSET key to set 0. If "E00" is shown again instrument needs to be repaired.
E01	Telescope turning too fast, press V/% key to set 0 for the vertical plate specification.
E02	Interior error of the horizontal angle measuring system. Power on the instrument again. If error is shown again instrument needs to be repaired.
E03	Interior error of the vertical angle measuring system. If error is shown again instrument needs to be repaired.
E04	Difference between every value exceeds 30" during the angle repeated measurement, press OSET key and measure repeatedly.
E05	Number of angle repeated measurement exceed 15, press key and measure repeatedly.
E06	Errors during the process of the vertical angle Oset or adjusting Oset when the clamp angle to the horizon exceeds 45°. Need adjusting repeatedly.

Attention:

Fully check every part of the instrument and see whether the operation coincides with the procedures after the error appears. If the error code is still shown after many checks please send the instrument for repair.

22 MOUNT AND DISMOUNT OF THE BASE PLATE

Loosening or tightening turning handle can easily mount or dismount the instrument to or from the base plate.

Dismount

Turn the fixed pull handle 180° counterclockwise. Hold the base plate by one hand, bring up the instrument using the carrying handle by the other hand.

Mount

Bring up the instrument by hand and aim the orientation block at the orientation slot. Mount the instrument on the base plate carefully. Tighten the fixed pull handle on the base plate.

23 CHECK AND ADJUSTMENT

Adjustment instruction

Adjust the eyepiece and focus it precisely to avoid the visual errors before the observation through telescope.

Adjustment should be carried out one by one according to the following steps because each step's adjustment is based on its former one's result. Disorder the steps will default the adjustment.

Tighten the screw after the adjustment! The strength applied should be suitable because overtighten will damage the thread.

After the adjustment repeat the inspection to make sure that the adjustment has been well done.

Inspect and adjust the plate vial

Inspection

Make the plate vial parallel with two footscrews among the three ones.

Center its bubble by adjusting the two footscrews.

Turn the instrument 180° and observe the bubble. Adjustment is needed if the bubble is not centered.

Adjustment

Calibrate the plate vial by using the adjusting pin to adjust its screw to make the bubble move center-oriented halfway of the offset.

The other halfway will be offset by performing the adjustment of the two levelling screws, which are parallel with the long vial.

Turn the instrument 180° and check if the bubble is centered. If not, repeat the steps mentioned above till the bubble is centered.

Turn the instrument 90° and center the bubble by adjusting the third levelling screw. Repeat the checking and adjustment steps above until the bubble stays centered no matter in which direction.

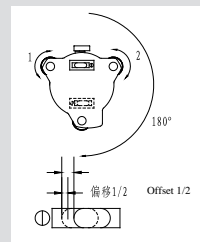

Inspect and adjust the circular vial

Inspection

If the circular vial is centered correctly after levelling the instrument according to the long vial, then no further adjustment is necessary. If not, please proceed with the following adjustment.

Adjustment

There are three adjusting screws on the bottom of the circular vial. When adjusting, loosen the screw opposite to the bubble's moving direction (one or two), then tighten the rest screws along the bubble's moving direction to center the bubble. The tightening strength of these three screws should be coincided.

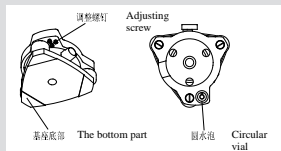

The telescope reticule

Inspection

Mount the instrument on the tripod and level it carefully.

Set target point A 50 meters to the instrument, aim at point A by the stadia hairs.

Turn the telescope and observe point A whether it moves along the vertical hair.

If point A moves along the vertical hair, that means the vertical hair is perpendicular to the horizontal axis, then no further adjustment is necessary.

Adjustment is necessary if point A moves deviated from the vertical hair

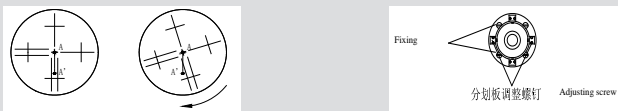

Adjustment

Turn counterclockwise and remove the reticle cover between the eyepiece and focusing knob, This will expose four reticle fixing screws.

Loosen these four fixing screws equally by screwdriver. Turn the reticle base around the visual axis to set point A on the vertical hair.

Tighten these four fixing screws equally and observe whether any deviation appears when point A moves along the vertical hair. If not, the adjustment is over.

Assemble back the reticle cover to its original position.

Perpendicular degree of the visual axis to the horizontal axis

Inspection

Set two obvious targets as high as the instrument about 100 meters apart with the instrument in their center point.

Level the instrument precisely and power it on.

Aim at target A using crosshair of the telescope plate-leftward.

Loosen the vertical braking knob. Rotate the telescope around the horizontal axis 180° to aim it at the opposite direction.

Aim at target B with the same distance to target A

Rotate the horizontal braking knob to turn the instrument 180° .

Aim at the target A, then lock the knob.

Rotate the vertical braking knob to turn the instrument 180° . Aim at target C. Target C should be superposed to target B. If not, adjustment is necessary.

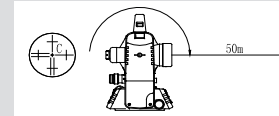
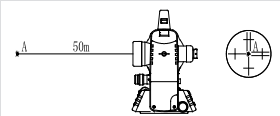
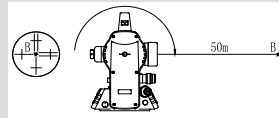
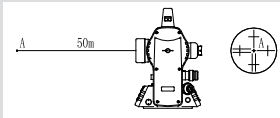

Adjustment

Remove the reticule cover between the eyepiece of the telescope and the focusing knob.

Set up point D between point B and C. The distance of DC should be a quarter of BC. Adjust the two adjusting screws to move the reticule to have its cross aim at point D.

Repeat above inspection and adjustment steps until B and C are superposed.

Assemble back the reticule cover to its original position.

Loosen one screw if the vertical hair of the crosshair should be moved, then tighten the other one in the same turn. Loosen the screw counterclockwise and tighten in clockwise direction. The turn should be as little as possible no matter loosen or tighten.

After the adjustment above, the zero reset of the vertical angle should be carried out.

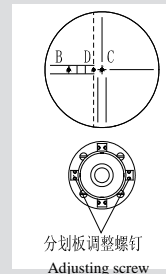

Automatic compensation of the vertical axis

The instrument is equipped with the electronic incline sensor device, which can compensate the vertical axis.

Check

After mounting and levelling the instrument, coincide the point of the telescope with the line between the center of the instrument and its any level screw. Then tighten the horizontal braking knob.

Set zero for indication of the vertical plate after power-on. Tighten the vertical clamp knob and the instrument displays the current value of the vertical angle the telescope pointed.

Turn the footscrew in one direction till 10 mm (circle distance). The value of vertical angle also changes correspondingly till it disappears and the symbol "b" is shown, which means the incline of the instrument's axis has exceeded out of the compensated range. When turning the levelling screw in reverse, the instrument returns to display the vertical angle (repeat testing and observe the changes on the critical point), which means the compensation device works well.

Adjustment

When the compensation doesn't work well or works abnormally, send to the factory for repair.

Vertical plate angle specification ("i" angle) and its 0 set

Check

After mounting and levelling, power on the instrument. Aim the telescope at any clear target A to get the reading L, which is the upright angle plate leftward reading.

Turn the telescope conversely and aim at target A again to get the reading R, which is the upright angle plate rightward reading.

If upright angle is in the zenith angle mode, then $i = (L + R - 360^\circ) / 2$.

If upright angle is in the vertical angle mode, then $i = (L + R - 180^\circ) / 2$ or $i = (L + R - 540^\circ) / 2$

If upright angle is in the height angle mode, then $i = (L - R) / 2$

If the specification errors $|i| \geq 10''$, 0 reset of the upright plate is necessary.

Adjustment

Operating procedures

Operation

Display

Level the instrument accurately with the plate vial.

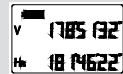

Power on the instrument, the vertical angle and horizontal angle are displayed after upright passes zero position.



Rotate the telescope



Press **FUNC** key once, and then press **V/%** key.

FUNC
V%

Rotate the instrument and precisely aim at the clear and stable target A as high as the instrument in the distance.

Aim at the left position of A plate



Press **OSET** key once.

OSET

Turn the instrument and aim the right of the vertical plate at the same target A.

Aim at the left position of A plate

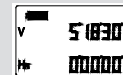

Press **OSET** key and the measured values are set. The instrument goes back to the angle measurement mode, and the calibration is finished.

OSET

Check the specification error i to see whether it is according to the requirements. If not, check whether the right adjusting procedure is performed, or whether the aim of the target is precise.

Reset as required.

Send the instrument to the factory for repair after operations are repeated many times without any effect.

Check and adjust the optical plummet

To superpose the optical axis of the plummet and the vertical axis, adjustment for the plummet is necessary, otherwise the vertical axis will not be on the true anchor point when the aim begins.

Inspection

Mount the instrument on the tripod and place a sheet of paper with a cross on it under the instrument.

After adjusting the focus of the optical plummet, move the paper to center the cross of the crosshair in the field of view.

Turn the collimator 180° , observe the superposed degree of the center mark and the cross.

If the center mark of the optical plummet and the cross of the hair keep superposed when turning the collimator, adjustment is unnecessary. If not, adjust it.

Adjustment

Turn counterclockwise and remove the adjusting screw cover between the optical centering device and the focusing knob.

Fix the sheet of paper with the cross on it and mark the fallen point of the center mark each time when the instrument turns 90° , shown as the illustration: point A, B, C, D.

Line up points on the cross AC and BD to get the point of their intersection O.

Regulate the four adjusting screws on the optical plummet with the adjusting pin to superpose the center mark and point O.

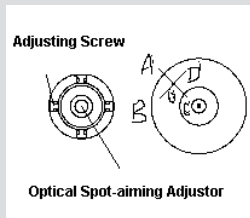

Other adjustment

Adjust the two levelling screws on the base plate if the screw loosens. The tightening strength should be suitable.

24 TECHNICAL SPECIFICATIONS

	FET 420K	FET405K
Telescope:		
Magnification	30 ×	30 x
Clear objective aperture	45 mm	45 mm
Shortest focussing distance	1,4 m	1,4 m
Angle measurement:	incremental	incremental
Accuracy	4 mgon (20")	1 mgon (5")
Shortest focussing distance	2 mgon (10")	0,5 mgon (2")
Compensator	Automatic compensation	Automatic compensation
Measuring units	400gon / 360° / mil	400gon/ 360° / mil
Display	2 x LCD	2 x LCD
Optical plummet:		
Magnification	3 x	3 x
Focussing range	0,5 to ∞	0,5 to ∞
Vials:		
Plate level	8'/2 mm	8'/2 mm
Power supply	4 x 1,5V AA Alkaline	4 x 1,5V AA Alkaline
Operating time	15 h	15 h
Temperature range	-20°C - +45°C	-20°C - +45°C
Tribrach	detachable	detachable
Weight	4 kg	4 kg

25 CARE AND CLEANING

- Please handle measuring instruments with care.
- Clean with soft cloth only after any use.
If necessary damp cloth with some water: If instrument is wet clean and dry it carefully.
- Pack it up only if it is perfectly dry.
- Transport in original container / case only.

26 INTENDED USE OF INSTRUMENT

Triangle, polygon and engineer measurements in the field of civil engineering as well as cadastral survey.

27 SAFETY INSTRUCTIONS

- Please follow up instructions given in operators' manual.
- Use instrument for measuring jobs only.
- Do not open instrument housing. Repairs should be carried out by authorized workshops only. Please contact your local dealer.
- Do not remove warning labels or safety instructions.
- Keep instrument away from children.
- Do not use instrument in explosive environment.

28 SPECIFIC REASONS FOR ERRONEOUS MEASURING RESULTS

- Measurements through glass or plastic windows;
- dirty laser emitting windows.
- After instrument has been dropped or hit. Please check accuracy.
- Large fluctuation of temperature: If instrument will be used in cold areas after it has been stored in warm areas (or the other way round) please wait some minutes before carrying out measurements.

29 ELECTROMAGNETIC ACCEPTABILITY (EMC)

- It cannot be completely excluded that this instrument will disturb other instruments (e.g. navigation systems);
- will be disturbed by other instruments (e.g. intensive electromagnetic radiation nearby industrial facilities or radio transmitters).

30 CE-CONFORMITY

Instrument has CE-mark according to EN 61326:1997, EN 55022, EN 61000-4-2/-3.

31 WARRANTY

This product is warranted by the manufacturer to the original purchaser to be free from defects in material and workmanship under normal use for a period of two (2) years from the date of purchase.

During the warranty period, and upon proof of purchase, the product will be repaired or replaced (with the same or similar model at manufacturers option), without charge for either parts or labour.

In case of a defect please contact the dealer where you originally purchased this product.

The warranty will not apply to this product if it has been misused, abused or altered.

Without limiting the foregoing, leakage of the battery, bending or dropping the unit are presumed to be defects resulting from misuse or abuse.

32 EXCEPTIONS FROM RESPONSIBILITY

The user of this product is expected to follow the instructions given in operators' manual. Although all instruments left our warehouse in perfect condition and adjustment the user is expected to carry out periodic checks of the product's accuracy and general performance.

The manufacturer, or its representatives, assumes no responsibility of results of a faulty or intentional usage or misuse including any direct, indirect, consequential damage, and loss of profits.

The manufacturer, or its representatives, assumes no responsibility for consequential damage, and loss of profits by any disaster (earthquake, storm, flood etc.), fire, accident, or an act of a third party and/or a usage in other than usual conditions.

The manufacturer, or its representatives, assumes no responsibility for any damage, and loss of profits due to a change of data, loss of data and interruption of business etc., caused by using the product or an unusable product.

The manufacturer, or its representatives, assumes no responsibility for any damage, and loss of profits caused by usage other than explained in the users' manual.

The manufacturer, or its representatives, assumes no responsibility for damage caused by wrong movement or action due to connecting with other products.

geo-FENNEL GmbH
Kupferstraße 6
D-34225 Baunatal
Tel. +49 561 49 21 45
Fax +49 561 49 72 34
Email: info@geo-fennel.de
www.geo-fennel.de

All instruments subject to technical changes.

08/2008