

OPERATION MANUAL

MULTI-FUNCTION DATALOGGER WITH PRINTER



INDEX

<u>Introduction</u>	1
<u>Material Supplied</u>	1
<u>Features</u>	1
<u>Comparison table</u>	2
<u>Meter keypad</u>	4
<u>Top cover of meter & Accessory</u>	5
<u>Meter setting</u>	6
Single measurement	7
Multiple measurement	8
Automatic logging	9
<u>Diagram</u>	
9871 Air flow logging printer	10
<u>Software</u>	
File	12
Mode	13
Port	14
Commad	14
Print	15
<u>Specification sheet</u>	16
<u>Trouble shooting</u>	17

INTRODUCTION

Thank you for purchasing this multiple function printer! This unit has been developed to meet your max.satisfaction by its user-friendly design. Please review the entire manual for a complete overview of how to operate this meter.

MATERIAL SUPPLIED

Check for damaged or missing parts in your meter before starting. The complete meter set should contain :

1. Meter
2. 4pcs AA batteries
3. Printing Thermo-paper
4. Operation manual
5. Carry Case
6. External Fan
7. RS232 cable
8. Software CD

Features

This meter designed with three measurement modes:

- 1)Single point measurement
- 2)Multiple points measurement (Manually record)
- 3)Automatically Logging

- Measuring/ProgrammingAnywhere, anytime
- User friendly interface
- RS232 cable and software enable to link with PC to download & upload
- Backlight function
- Tripod mountable for long time use
- Power off time selectable
- Big Dot matrix LCD
- Powered by 4pcs AA batteries or 9V adaptor
- Printing anywhere, anytime.

COMPARISON TABLE

Measured parameters of each meter:

MODEL	FUNCTION	PARAMETERS
9871	Anemometer	Velocity, Humidity Temperature Wet Bulb, Air Volume

Please refer to below for the difference of each measurement mode.

MEASUREMENT	DESCRIPTION	MEMORY POINT
Single Point Measurement	Single point measurement	No Memory
Multiple Point Measurement	File name editable multiple point measurement	99 points
Automatic Logging	Programmable datalogging function	2400 points

Comparison table of multiple points and datalogging measurements

	MULTIPLE POINT MEASUREMENT	DATALOGGING
RECORD	99 points	2400 points
FILE NAME	Editable or Default with date and time <u>(Note 1)</u>	Default <u>(Note 2)</u>
MEASURING / SAMPLING	Press "MEAS" key to measure and store by pressing specified keys	Automatically measure and store according to pre-set parameters <u>(Note 3)</u>

Note 1: Each record is designed to show with current date and time if user doesn't edit any.

For example : if the file name is "05-06 09:21:51" means the date is 6th May (or 5th June, based on your date mode setting)and the time is 09:21:51.

Note 2: Each record is designed to show with the current date and time.

- Note 3: a)To set up Begin-Date,Start-Time,End-Date,Suspend-time and sample rate from the meter.
b)Each meter starts to record from Begin-Date & time with specified sample rate until Suspend-time.
c)Automatically start again next day from Start-Time until End-Date.
d)Logging stops recording when End-Date or max. memory points is achieved.
e)Logging can be stopped and start again with the same setting.

METER KEYPAD-WITH PRINTER

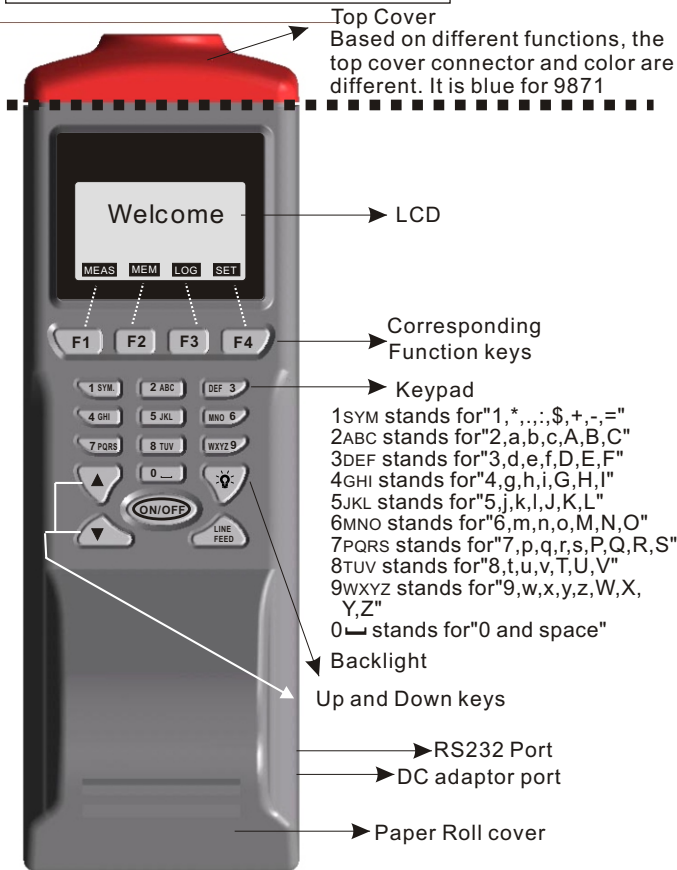

ACCESSORY

9871



The temperature and humidity sensors are built in the fan, so remember to rotate the cover before using to get accurate reading.

TOP COVER -CONNECTOR

The following illustration is the connector for 9871.

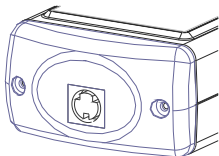

METER SETTING

Before measuring, please check the meter setting first to confirm the basic settings of the meter are what you need.

To enter each command, just press the corresponding F1 to F4 key.

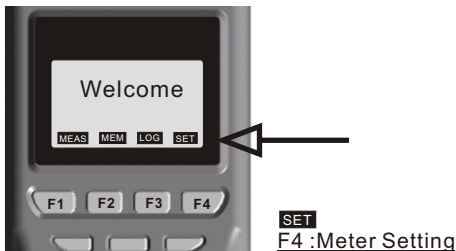

- Pressing ▲ or ▼ key to shift the cursor.
- Pressing EDIT to enter modification mode.
- Pressing PRN to enter printing mode.
- Pressing NEXT/BACK to enter next or previous page.
- Pressing EXIT to return to main menu

Descriptions :

- LCD Cont.(1-5): LCD brightness. From darkest 1 to brightest 5
- Prn Cont. (1-9): Printing darkness. From lightest 1 to heaviest 9
- Unit: The unit could be metric or imperial / °C or °F
- Auto Off: The selectable time frame is 1 to 20 min.
- Set Clock: To choose the date mode and set your local time.
Date mode:MM-DD-YY or DD-MM-YY or YY-MM-DD
- Set ID: If choose "Disable", the ID will not be printed out.
- ID: To edit an ID of this printer , the ID will be printed out at printing mode.
- Select item: To select which measured parameters need to be showed on the LCD. The unit of each parameter could be selected from here as well.

SINGLE MEASUREMENT

There are three measurement modes :

1. Single measurement(MEAS)
2. Multiple measurement(MEM)
3. Auto logging (LOG).

Operating the single measurement as a general meter.

MEAS

F1 :Single Measurement



Definition

- Press F1 (MEAS) to proceed single measurement.
- After entering measurement mode , press F4 (PRN) to enter printing mode. The printing can be stopped any time by press F1(STOP or EXIT) key while it is printing .
- The printing contrast can be changed by pressing HIGH or LOW key .
- PH & external probe calibration mode introduction are in the mode of Single measurement .

MULTIPLE MEASUREMENT

This is to manually record what you measured with real time , and file name (a note or identification for the record) is editable to memorize or recognize .

There are total 99 memorize capacities in this measurement.

MEM

F2 :Multiple measurement



Definition

- Press MEAS to measure the parameters.
- Select F1(ABORT) or F4(SAVE) to exit the measurement or memory the record .
- Press F3 (Edit) to edit the file name of recorded value .
While editing the file name, select from the keys 1SYM, 2ABC, 3DEF, 4GHI...., Press and hold one of the key to select from the displayed letters by releasing the key .
- Press CLR shortly to delete one data or press for over 2 seconds to delete the whole memory.
- Before printing, select the printing range by pressing EDIT key, then press START to print.

AUTOMATIC LOGGING

This is to automatically record what you set up before measurement with real time, first to set records start/stop date and time, sample rate , memory points. The screen content shows Expect memory points and Remain memory points while in setting.

LOG

F3 :Datalogging



Definition

- Press SET to set needed setting first. The Date mode is based on the mode you set under SET (see page 6). The sampling rate is from 1 to 7200 seconds. "Expect" means total memory of this meter, "Remain" means how many memory left in meter.
- Press START to begin the logging function. While logging: Press VIEW to see the data (more than one) in the screen, or press MEAS to see a real-time data, or press STOP to quit logging.
- Press P-PG or N-PG to review previous or next 100 points. After stopping, press START to begin again. The sampling rate and previous record are remained if the previous setting has not been changed.
- "Suspend" is the stop time of each day during setting date. If you want to record 24 hours a day, you have to set : 00:00:00 as "Start" , and 23:59:59 as "Suspend" .

9871 Anemometer +Psychrometer Setting/Single measurement

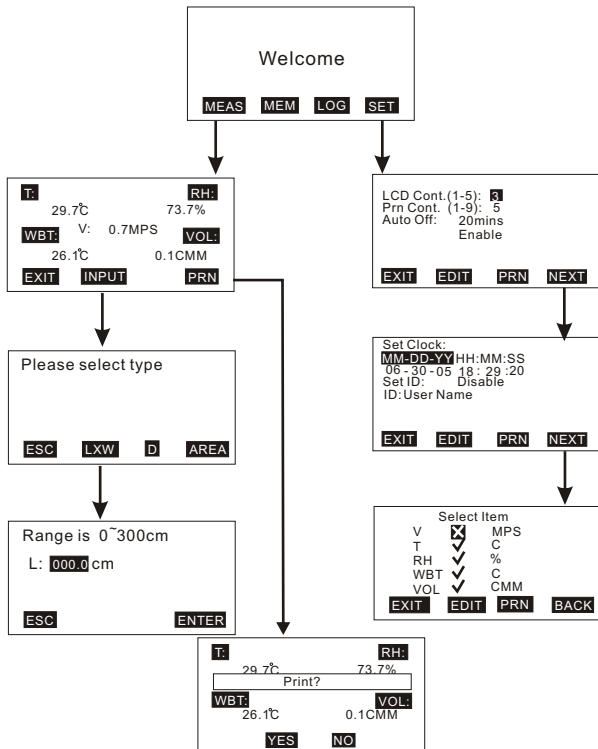

Remarks:

1. To calculate Air Volume, first input the value of the Air source area. There are three choices: length x width (Rectangle), Diameter (Round) and Area (Input the most accurate value).
2. The available range is shown on the LCD to remind user.
3. Rectangle and round setting range: 0~300cm or 0~110inch
Outlet area setting range: 0~90000sq.cm or 13000 sq.inch.

9871 Anemometer +Psychrometer Multiple meas/Datalogging

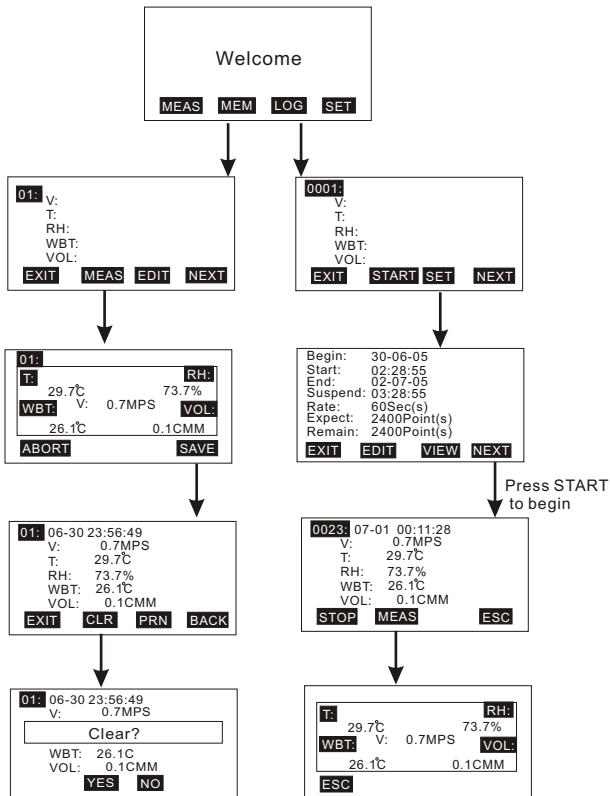

Remarks:

1. "Select Item" : There are 2,400points for each item, press EDIT to cancel the item you don't want to record. Meter will only record the items you checked off .

SOFTWARE

The enclosed software is a quick tool for you to download the memorized data to PC for further analysis or upload the pre-edited file names to meters, this may save your setting time.

Material & O/S

- Software CD and RS232 cable with D-sub plug are needed.
- Operating system need to be WIN98/2000/NT/XP or above.

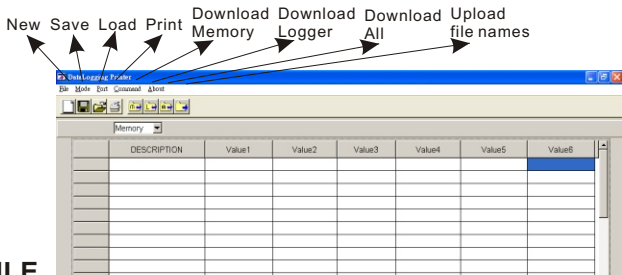

FILE

- New: To create a new file.
- Load: To open a saved file.
- Save: To save current file.
- Save as: To save current file as new file name.
- Print: To print all data or logging data or memory data.
- Exit: To withdraw the software

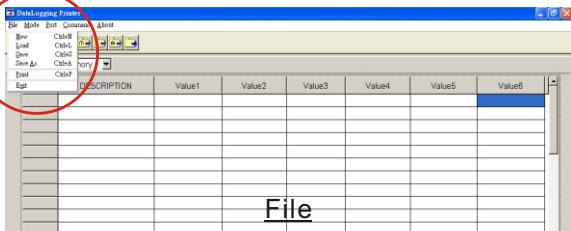

File

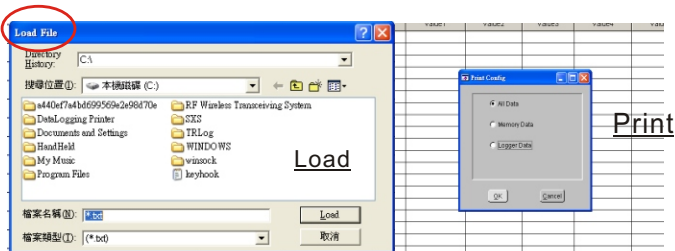

MODE

- There are two data modes. One is Memory, the other one is Logger.
- To select the mode from main menu or quick selection window.
- In logger mode, you may select from "Goto" to choose logged data range. There are 100 points in one page.

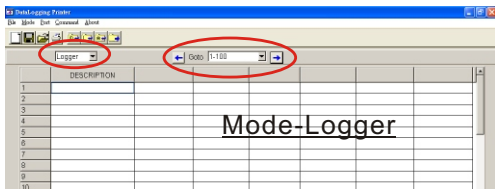
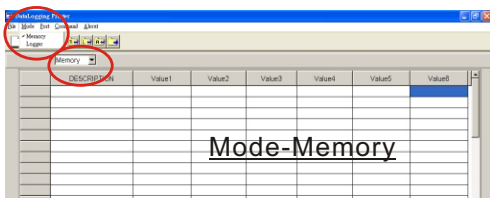

PORT

- Select the correct Com. port to ensure the meter is communicated with PC. In connecting mode, "PC Mode" will appear on the LCD and "COM #" & Edit will show on the left bottom corner of screen.
- For most PCs, the Com. port number is COM1.
- There are 8 COM ports for selection in this software.

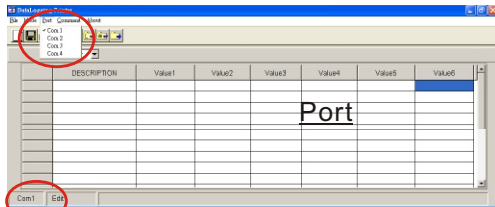

COMMAND

- There are four commands in this software.
 - Download measured logging data from meter to PC.
 - Download measured memory data from meter to PC.
 - Download measured logging & memory data from meter to PC.
 - Upload pre-edited file names from PC to meter.
- To edit the file names, click left key of mouse twice quickly , then the cursor will flash to indicate the column is ready for editing.
- Before uploading or downloading, make sure you choose the correct download mode . If you choose "Download memory data" but execute downloading "Logger data" , you will have to switch the mode to have the correct display.

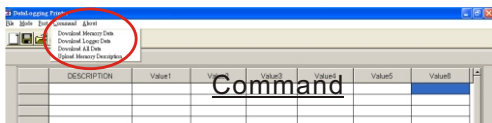

PRINT

Select the data you want to print : There are 3 selection :

1. Print only Logger Data
2. Print only Memory Data
3. Print all (Both Logger Data and Memory Data in sequel)

Example: (If you choose Print all from 9811 IR meter)

Page1

<< DataLogging Printer Report Date:07-12-2005 TIME:17:26:30 >>

Memory Data:

STEP	DESCRIPTION	Temp
1	07-12 10:46:24	26.2 C
2	07-12 10:46:30	26.5 C
3	07-12 10:46:33	25.8 C
4	07-12 10:46:38	25.9 C
5	07-12 10:46:48	26.1 C







.....

Logger Data:

STEP	DESCRIPTION	Temp
1	07-12 13:00:00	28.5 C
2	07-12 13:10:00	28.4 C
3	07-12 13:20:00	28.0 C
4	07-12 13:30:00	27.8 C
5	07-12 13:40:00	28.1 C

.....

98XX SERIES SPECIFICATION SHEET

PRINTER SERIES	9811/9812	9861	9871	9881/9882	9880	9851	983X
Photo							
Specialize / Type	IR thermometer w/o probe:9811 w/probe:9812	pH meter	Air flow meter	Thermometer K type:9881 K,J,T,R,S,E.:9882	IrDA receiver	Humidity Meter	Manometers +/-2psi:9832; +/-5psi:9835 +/-15psi:98315; +/-30psi:9833 +/-100psi:9831
Programming	√	√	√	√	√	√	√
Downloading	√	√	√	√	√	√	√
Printing	√	√	√	√	√	√	√
Link to PCs	√	√	√	√	√	√	√
Backlight	√	√	√	√	√	√	√
Resolution	0.1C/0.1F (<110C), 1C/1F (>110C)	pH : 0.01 Voltage : 0.1mV	Temp:0.1C RH:0.1% WB:0.1 Air Velocity:0.1m/s Air Volume:0.1-1	0.1C/1C		Temp:0.1C RH:0.1% WB:0.1 DP:0.1	Check catalog for the details
Accuracy	+/-2% or 2C in -20~200C; (which is greater) +/-3% or 3C in other range	pH : +/-0.02 Voltage: +/-0.2mV at -99.9~99.9mV, +/-2mV at others	Temp: +/-0.5C RH: +/-3% at 10~90%RH +/-5% at others Air Velocity: +/-3% Air Volume: +/-3%	0.3%rdg+0.7C		Temp: +/-0.6C RH: +/-3% at 10~90%RH +/-5% at others	+/-1%
Manual Memory	99	99	99	99	99	99	99
Datalogging measurement	9811:12000 points 9812:6000 points	4000 points	2400 points	4000 points	Up to 12000points	3000 points	12000 points
Dimension (mm)	206(H) x 70(W) x 53(T) mm						
Battery	4pcs AA batteries						
Hard Carry Case	√						
Interface Cable	√						
DC Adapter	Optional						
Software	√						
Remarks					For AZ mede IrDA products		

TROUBLE SHOOTING

1. Power on but no display
 - a) Make sure the time of pressing "ON/OFF" key is more than 200 milliseconds.
 - b) Check the batteries are in place and make sure they are at good contact and correct polarity.
 - c) Replace with new batteries and try again .
 - d) Move the batteries for ten seconds ,then replace back again.

2. Display disappear
 - a) Check whether the low battery indicator is displayed on or before display disappears. If yes , replace with new batteries .

3. Error code:
 - 1) E2. Problem : Meter value is under flow .
 - 2) E3. Problem : Meter value is overflow.
 - 3) E4. Problem: Calculated source value occurs error.